







4T

-  1745 mm
-  4000 kg
-  1999 mm
-  2060 mm
-  3,0 kw
-  (3 ~) 400/50V / Hz
-  880 kg







KN3640E

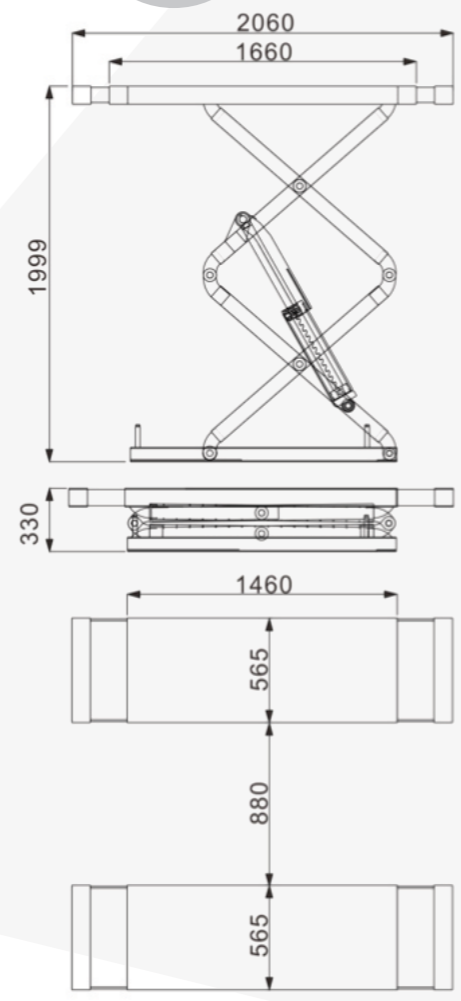

4T



-  Seguros mecánicos reforzados
-  Assurance mécanique renforcée
-  Reinforced mechanical lockers
-  Assicurazione meccanica rinforzata

 **ELEVADOR DE TIJERAS PARA EMPOTRAR DE 4000KG**

- Fotocélula de nivelación que bloquea en caso de una descompensación accidental de la plataforma
- Sistema hidráulico con accionamiento principal/auxiliar y válvulas paracaídas de seguridad.

 **PONT ÉLÉVATEUR À DOUBLE CISEAUX À ENCASTER 4000KG**

- Photocellule de niveau qui se bloque en cas de décompression accidentelle de la plate-forme.
- Système hydraulique de qualité APLUS (pompe-piston) pour une longue durée de vie de l'équipement.

 **IN GROUND SCISSOR LIFT 4000KG**

- Leveling photocell that blocks in case of accidental decompensation of the platform.
- Hydraulic system (pump-piston) of A-PLUS quality which guarantees a long life of the equipment.

 **SOLLEVATORE A FORBICE AD INCASSO 4000KG**

- Fotocellula di livellamento che blocca la macchina in caso di sbilanciamento accidentale della piattaforma.
- Sistema idraulico (pompa-pistone) di qualità A-PLUS che garantisce una lunga vita agli strumenti.

KN3640E



ES: Escanee el código para más información.
EN: Scan the code for further information.
FR: Scannez le code pour plus d'informations.
IT: Scansiona il codice per maggiori informazioni.

