











-  12"- 24"
-  800 mm
-  1.5 - 20"
-  0.25kw
-  (1 ~) 220V
-  1.15 x 0.95 x 0.98 m
-  146 kg



-  Alta precisión, Fácil de operar, Fácil de montar.
-  Haute précision, Facile à utiliser, Facile à assembler.
-  High accuracy, Easy to use, Easy to assemble.
-  Alta precisione, Facile da utilizzare, Facile da montare.

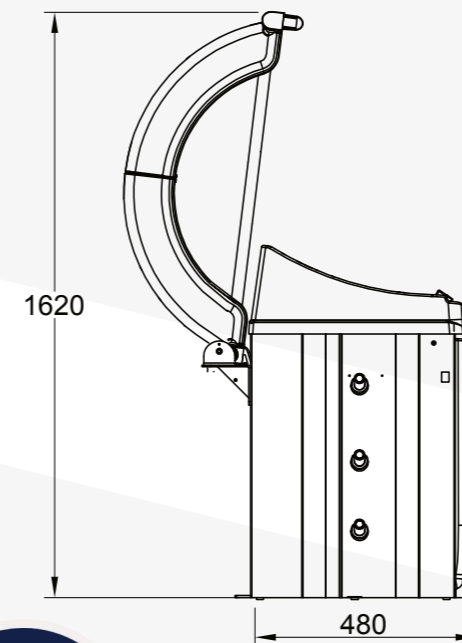
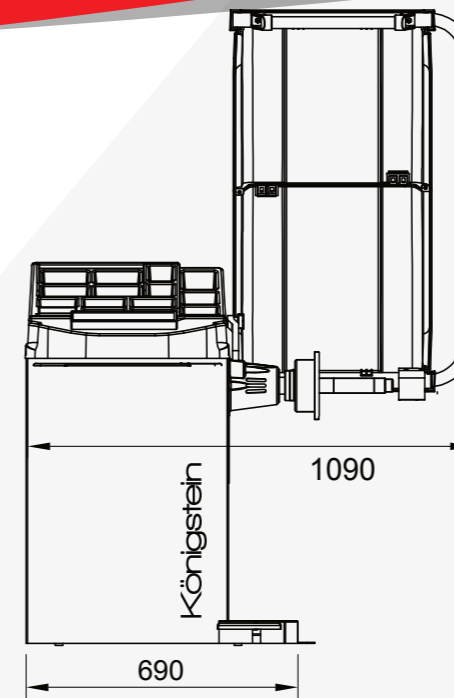

EQUILBRADORA PARA RUEDAS DE 12"- 24"

- Función de medición dinámica y estática.
- Función de auto-calibración
- Modos de medición ALU 1,2 y 3 dinámico y estático.
- Sistema de operación geométrico

EQUILIBREUSE MESURE AUTOMATIQUE POUR ROUES DE 12"- 24"

- Fonction de mesure dynamique et statique.
- Fonction d'auto-calibration
- Modes de mesure ALU 1,2 y 3 dynamique et statique.
- Système de géométrie

BASIC PROFESSIONAL BALANCER IDEAL FOR 12"- 24" WHEELS

- Dynamic and static measurement
- Self-calibration
- ALU 1,2 y 3 dynamic and static program.
- Geometric operating system

EQUILIBRATRICE BASICA PROFESSIONALE PER RUOTE DI 12"- 24"

- Funzione di misurazione dinamica e statica.
- Funzione di auto-calibrazione
- Modalità misurazione ALU 1,2 e 3, dinamica e statica.
- Sistema di operazione geometrica.

Königstein



-  Localice los accesorios dentro de la máquina
-  Les accessoires se trouvent dans une tiroir située en bas à l'intérieur de la machine
-  Find the accessories inside the machine
-  Gli accessori sono situati nel cassetto in fondo alla macchina

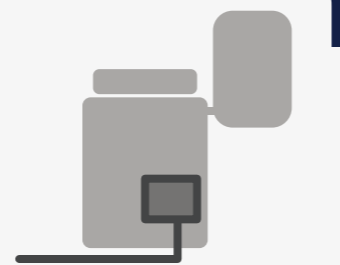

ES: Escanee el código para más información.

FR: Scannez le code pour plus d'informations.

EN: Scan the code for further information.

IT: Scansiona il codice per maggiori informazioni.

